

Data Sheet



Article number: 20301328

Description: E+G Handwheel
DIN 950-GG-180-B18-A

Measures

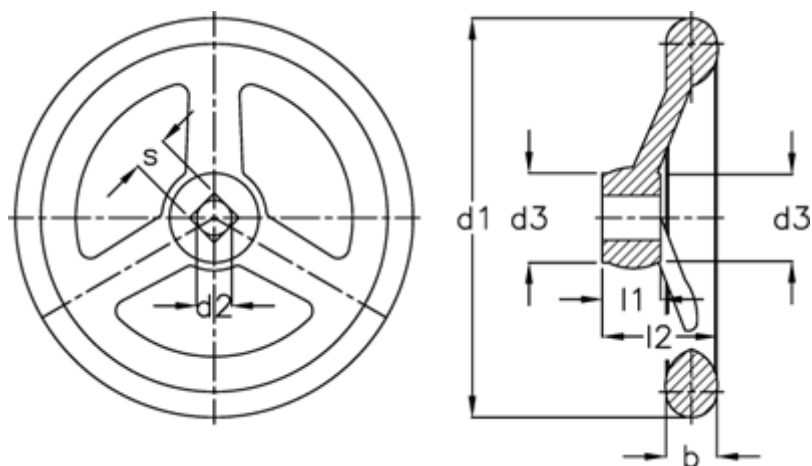

b	= 20
d1	= 180
d2 H7	= 18
d3	= 35
l1	= 22
l2	= 43
Number of spokes	= 3